

TPI Polene Power Public Company Limited

Investor Presentation



Table of Content



Section

1. Company & Business Overview
2. Financial Highlights
3. Key Operation Highlights



Company & Business Overview

TPIPP at a Glance



TPIPP is the largest operator of waste-to-energy (“WTE”) power plants in Thailand in terms of installed power generation capacity

Key Business Segments

% of Q2 2020 Total Sales Revenue



Energy & Utilities

- Operates refuse derived fuel (“RDF”) fired & waste-heat recovery power plants with off-take arrangements with EGAT and TPIPL
 - 8 commercially operating power plants TG1-TG8-440MW
 - Peripheral RDF production facilities to support its RDF-fired power plant operations

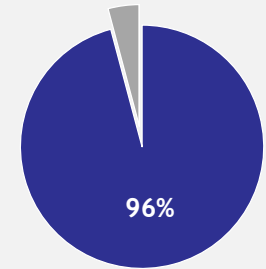

THB 2,678.18 mm



Petrol & Gas Stations

- Operates petrol stations and gas stations in Bangkok and other provinces in Thailand
 - Currently owns and operates 8 petrol stations, 1 gas station and 3 petrol and gas stations
 - Revenue derived from the sale of petrol, gas and convenience store goods

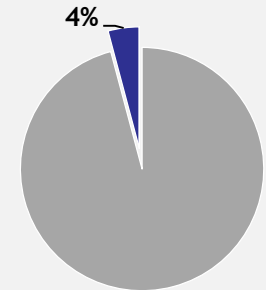

THB 115.96 mm



Summary of TPIPP's Power Plant Operations

TPIPP's Power Plants (Operational & Under Construction)

Total capacity in operation **440 MW**

Power Plant	COD	Installed Capacity	Off taker
In operation			
WHPP-40MW	Jun 2009	40 MW	TPIPL
RDFPP-20MW	Jan 2015	20 MW	EGAT
RDFPP-60MW	Aug 2015	60 MW	EGAT
WHPP-30MW ⁽¹⁾	Jan 2016/Apr 2018	30 MW	TPIPL/EGAT
RDFPP-70MW ⁽¹⁾	Apr 2018	70 MW	EGAT
Coal-RDF-PP-70MW	Aug 2018	70 MW ⁽²⁾	TPIPL
Coal-PP-150MW	Jan 2019	150 MW	TPIPL

Notes:

- (1) After commencing commercial operations in January 2016, WHPP-30MW initially sold power to TPIPL to be used in TPIPL's cement production process until RDFPP-70MW commences commercial operations. Since RDFPP-70MW commenced commercial operations in April 2018, WHPP-30MW, together with RDFPP-70MW, operated as a 100 MW RDF-fired power plant (RDFPP-100MW) and sold power produced from such plant, using RDF and waste heat, to EGAT.
- (2) Approved capacity of 40 MW.

TPIPP's Installed Capacity Breakdown by Fuel

MW

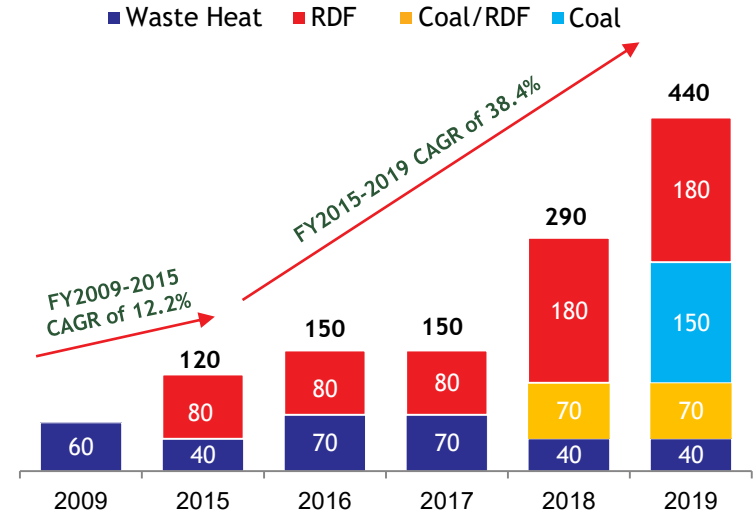

TPIPP's Q2 2020 Energy & Utilities Revenue Breakdown

THBmm

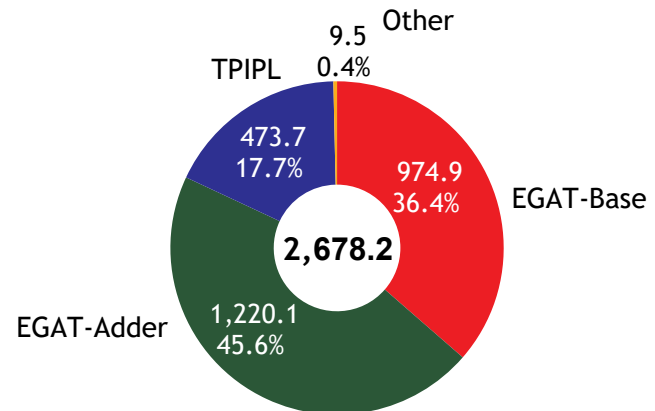



Summary of TPIPP's Petrol & Gas Station Operations

- TPIPP primarily sells petrol and gas to retail customers under the “TPIPL” brand
- The Company was granted the license to use the trademark of TPIPL in accordance with a 10-year trademark licensing agreement dated March 7, 2016 between the Company and TPIPL (the “TPIPL Trademark Agreement”) in connection with the Company’s sales of certain petrol and gas products

Breakdown of TPIPP's Petrol & Gas Stations by Type and Location

Location	Number of petrol stations	Number of gas stations	Number of petrol and gas stations	Total
Bangkok	2	-	1	3
Saraburi province	4	1	1	6
Nakornsawan province	1	-	-	1
Ubonrajthani province	-	-	1	1
Samutprakan province	1	-	-	1
Total	8	1	3	12

Historical Sales Volume

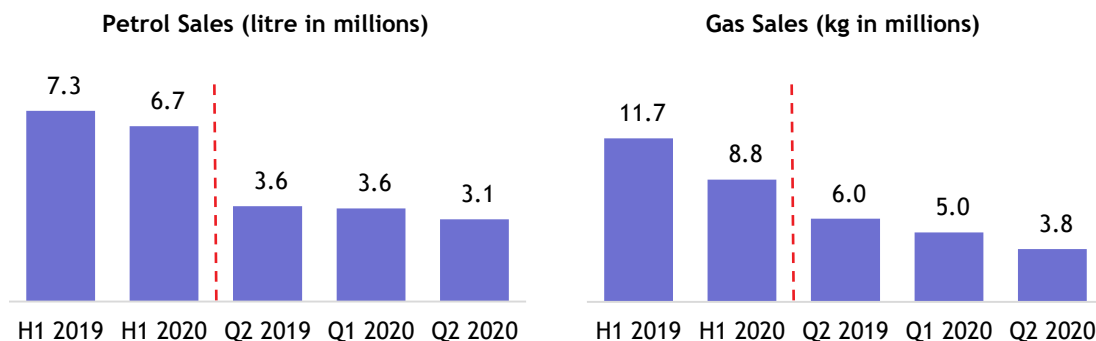

Supply of Petrol and Gas

Procurement of Petrol

- From oil companies at market price on a spot basis

Procurement of Petrol for Petrol Stations in the Saraburi province

- Also purchases from TPIPL at cost. TPIPL regularly purchases petrol at large volumes and at discounted prices in the open market

Procurement of Gas

- Agrees to purchase a minimum amount of gas from PTT Public Company Limited every month, ranging from 700,000 kilograms to 1,200,000 kilograms per month

Board of Investment Privileges

- One of the gas stations has been granted promotion certificates from BOI, which entitles it to a number of benefits including tax exemptions from certain taxes
 - Expiration of Full Income Tax Exemption:
 - July 2017
 - Expiration of 50% Income Tax Reduction:
 - July 2022

Mutually Beneficial Support Framework with TPIPL

Complementary Sale & Purchase Relationship with TPIPL Supports Continuing Development of Both Companies

Backing and Continuing Support from Recognized Shareholder, TPIPL

- One of the leading cement manufacturers in the country founded in 1987 and is listed on the Stock Exchange of Thailand since 1990
- Primarily engages in the business of manufacturing and selling cement & low-density polyethylene/ethylene vinyl acetate plastic resin as well as selling construction materials

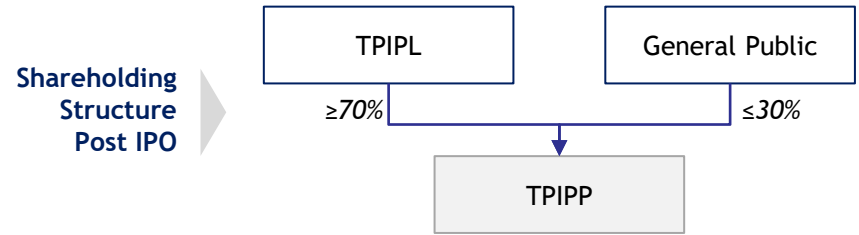

Waste Heat Supply & Power Sales Arrangements with TPIPL

TPIPL sells waste heat to TPIPP

TPIPP Utilizes Waste Heat Emitted from TPIPL's Cement Production Process

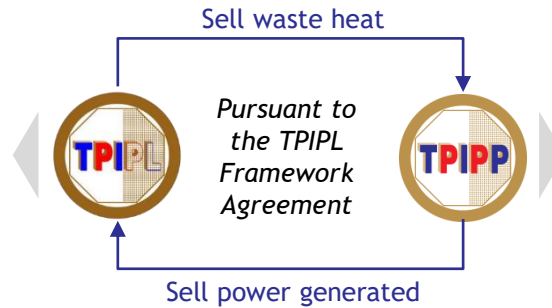
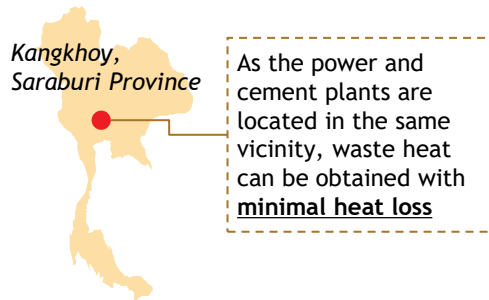

TPIPP sells power to TPIPL

Pursuant to the respective PPAs⁽¹⁾

Installed Power Generation Capacity (MW) with TPIPL as Offtaker

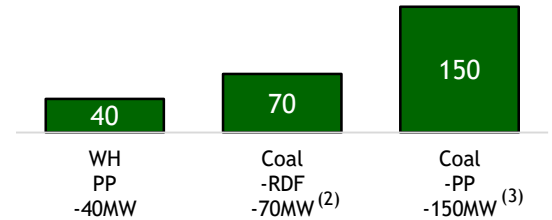

Notes :
 (1) PPAs do not specify a contracted power generation capacity
 (2) TG7 COD in August 2018. (under an approved power generation capacity of 40 MW)
 (3) TG8 COD in January 2019.



Financial Highlights

Revenue

Diversified Revenue Streams Led by Growing Revenues from Energy & Utilities Division



Total Revenue from Sales of Goods (THBmm)

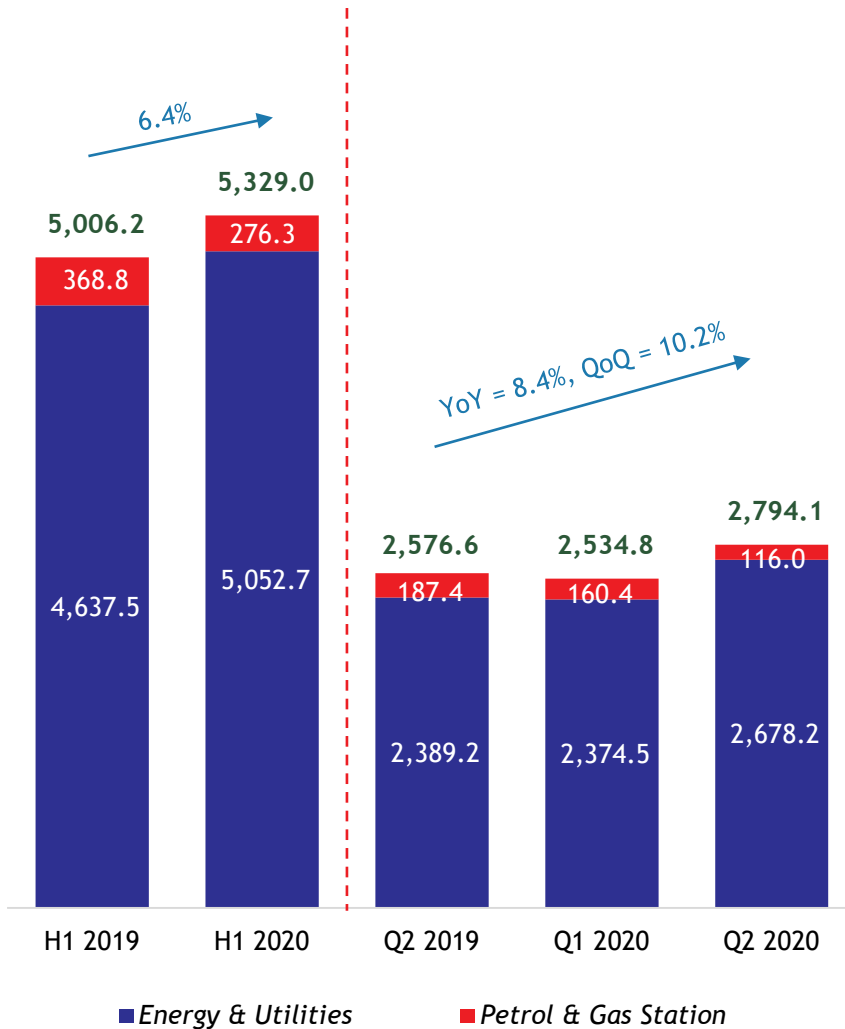

Revenue from Energy & Utilities (THBmm)

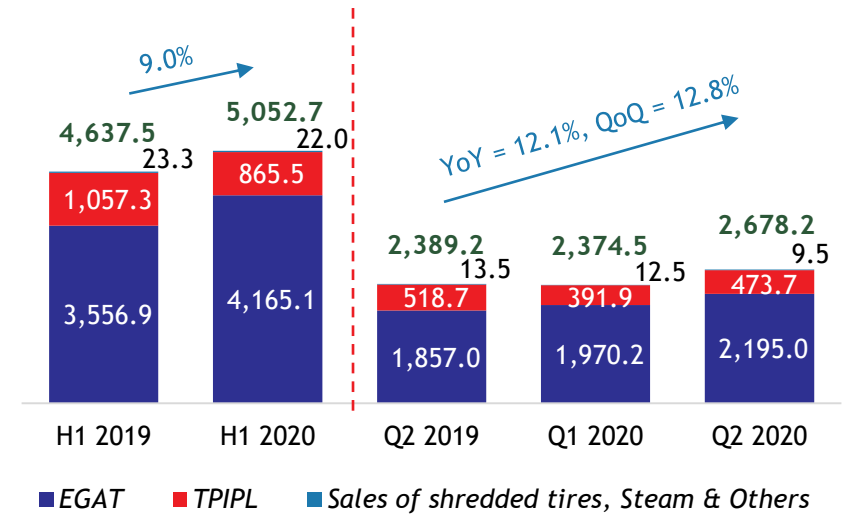

Revenue from Petrol & Gas Station (THBmm)

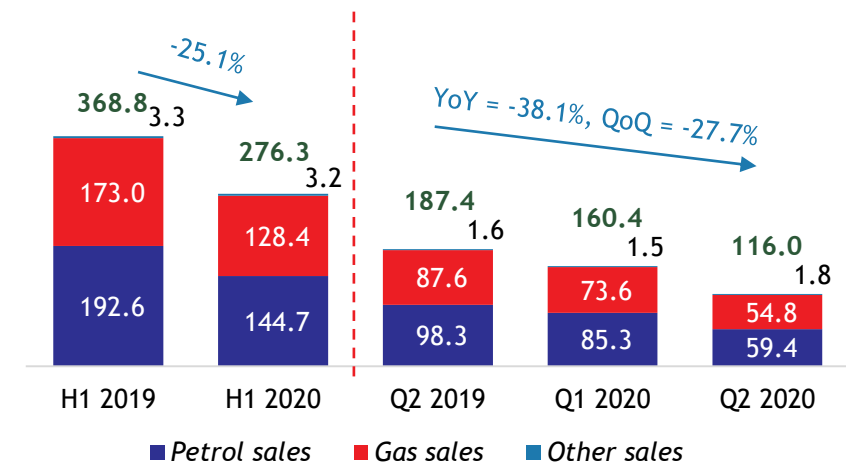

Cost of Sales & Gross Profit

Q2 Y2020 Cost of Sales Breakdown (THBmm)

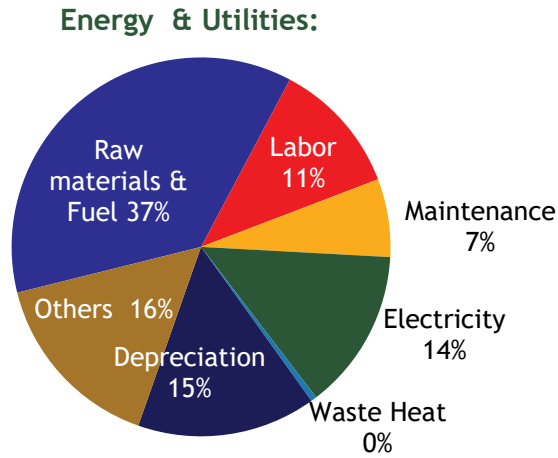

Total: THB 1,447.4 mm

Petrol & Gas Station:

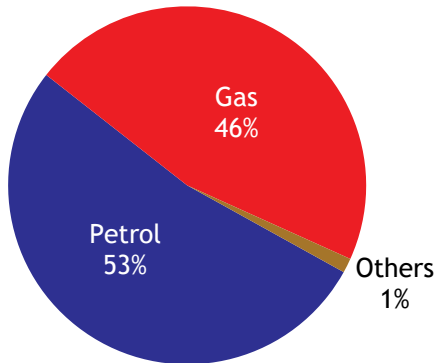

Total: THB 100.0 mm

Gross Profit (THBmm) and Gross Profit Margin⁽¹⁾ (%)

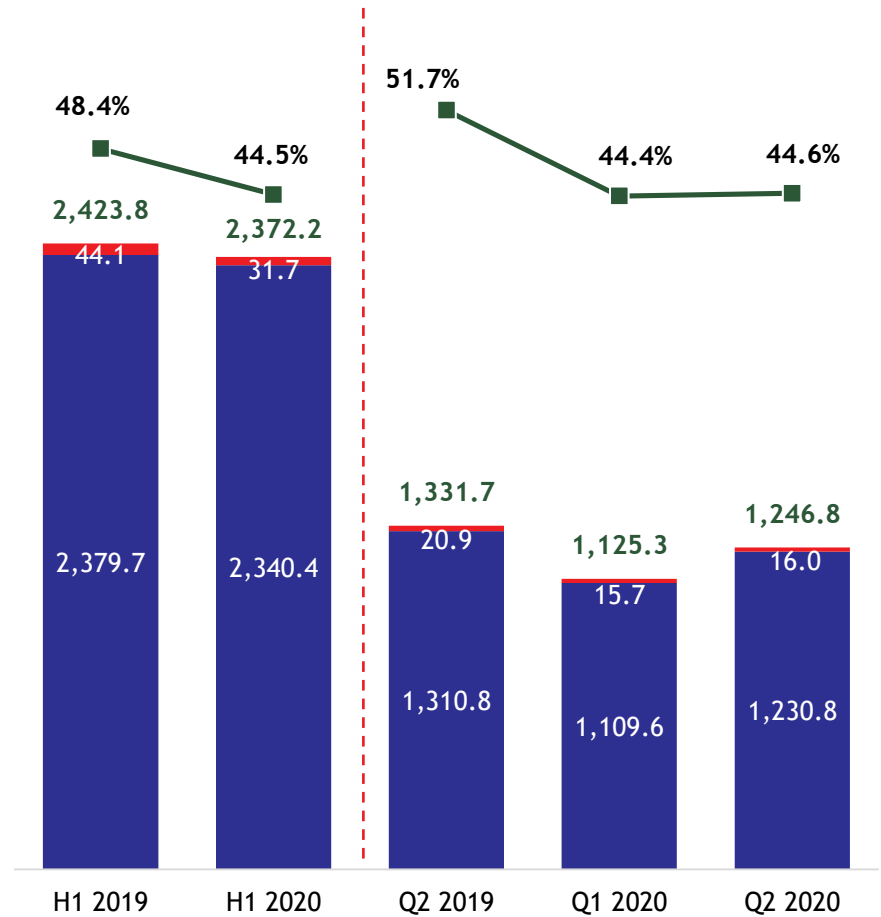

■ Energy & Utilities ■ Petrol & Gas station ■ Gross Profit Margin

Note:

(1) $Gross\ profit\ margin = \frac{Gross\ profit\ (loss)}{Revenue\ from\ sales\ of\ goods} \times 100$

Cost & Expenses vs. EBITDA & NPAT

Cost & Expenses Items (THBmm)

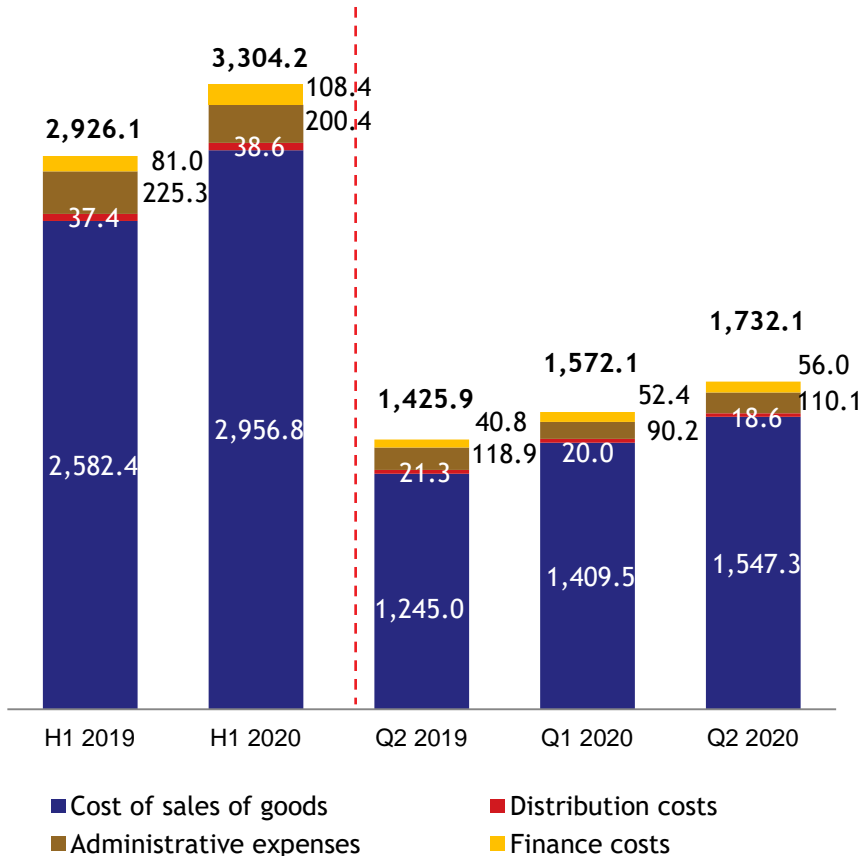

Operating EBITDA⁽¹⁾ (THBmm) and Operating EBITDA margin⁽²⁾ (%)

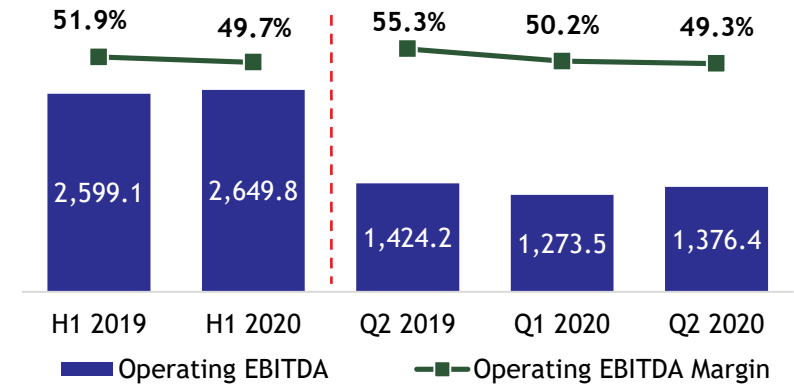

Operating NPAT (THBmm) and NPAT margin⁽³⁾ (%)

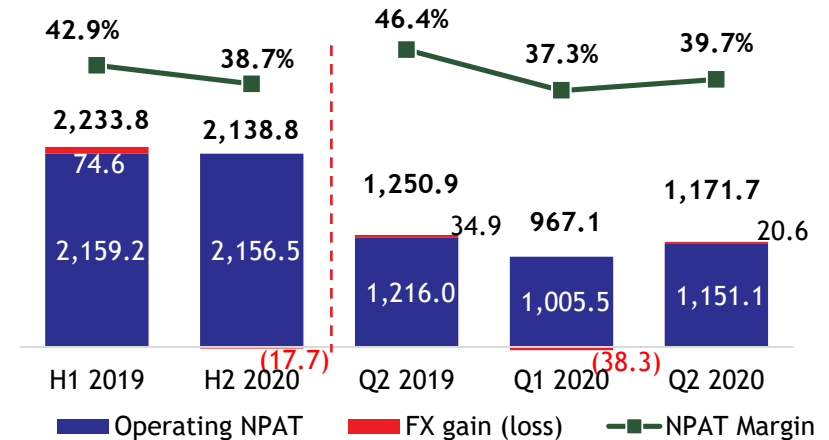

Notes:

- (1) Operating EBITDA exclude net foreign exchange gain(loss) and compensation from insurance claims. The Company considers EBITDA to be an important performance measure and the Company believes that EBITDA is used by many industries and investors as one measure of cash flow from operations. EBITDA should not be considered by an investor as an alternative to actual cash flow from operations as determined in accordance with TFRS, and is not a standard measure under TFRS. The Company's calculation of EBITDA may differ from similarly titled computations of other companies.
- (2) Operating EBITDA margin = operating EBITDA / Revenue from sales of goods and services x 100
- (3) Net profit margin = Profit (loss) for the year / Total Revenues x 100

Comparing Profit and Loss Statement - YoY and QoQ



Unit :THBmm

	2019	2020	2019	2020	2020	Compare (%)		
	H1	H1	Q2	Q1	Q2	YoY (H)	YoY (Q)	QoQ
Income								
Revenue from base tariff	2,637.4	2,723.7	1,346.9	1,275.2	1,448.6	3.3%	7.5%	13.6%
Revenue from power adder	1,976.8	2,307.0	1,028.8	1,086.8	1,220.1	16.7%	18.6%	12.3%
Other Sales Revenue	392.0	298.3	200.9	172.8	125.4	-23.9%	-37.6%	-27.4%
Other income	54.8	79.0	27.7	39.9	39.1	44.0%	41.0%	-1.9%
Operating Revenues	5,061.1	5,408.0	2,604.4	2,574.7	2,833.2	6.9%	8.8%	10.0%
Expenses								
Cost of sales of goods	2,582.4	2,956.8	1,245.0	1,409.5	1,547.3	14.5%	24.3%	9.8%
Distribution & administrative expenses	262.8	239.0	140.1	110.2	128.8	-9.0%	-8.1%	16.9%
Operating expenses	2,845.2	3,195.8	1,385.1	1,519.7	1,676.1	12.3%	21.0%	10.3%
Operating EBIT	2,215.9	2,212.2	1,219.3	1,055.0	1,157.1	-0.2%	-5.1%	9.7%
Plus Depreciation & Amortization	383.2	437.7	204.9	218.5	219.2	14.2%	7.0%	0.3%
Operating EBITDA	2,599.1	2,649.8	1,424.2	1,273.5	1,376.4	2.0%	-3.4%	8.1%
Compensation from insurance claims	41.3	91.1	41.3	3.1	88.0	120.8%	113.3%	2,721.8%
Net foreign exchange gain (loss)	74.6	(17.7)	34.9	(38.3)	20.6	-123.8%	-41.0%	153.8%
Total EBITDA	2,714.9	2,723.2	1,500.3	1,238.3	1,485.0	0.3%	-1.0%	19.9%
Investment income	34.2	25.5	16.8	18.4	7.1	-25.6%	-57.8%	-61.3%
Finance costs	(81.0)	(108.4)	(40.8)	(52.4)	(56.0)	33.9%	37.0%	6.7%
Income tax expense	(51.2)	(63.8)	(20.5)	(18.6)	(45.2)	24.6%	120.3%	143.0%
Depreciation & Amortization	(383.2)	(437.7)	(204.9)	(218.5)	(219.2)	14.2%	7.0%	0.3%
Net Profit (loss) for the year	2,233.8	2,138.8	1,250.9	967.1	1,171.7	-4.3%	-6.3%	21.1%



Generated Amount of Electricity (M.KWh) and Capacity (MW)

	2019	2020	Diff	%Change
Q2	492.01	545.46	+53.45	+10.86%
H1	970.94	1,019.46	+48.52	+5.00%

	Q1 2020	Q2 2020	Diff	%Change
3M	474.00	545.46	+71.46	+15.08%

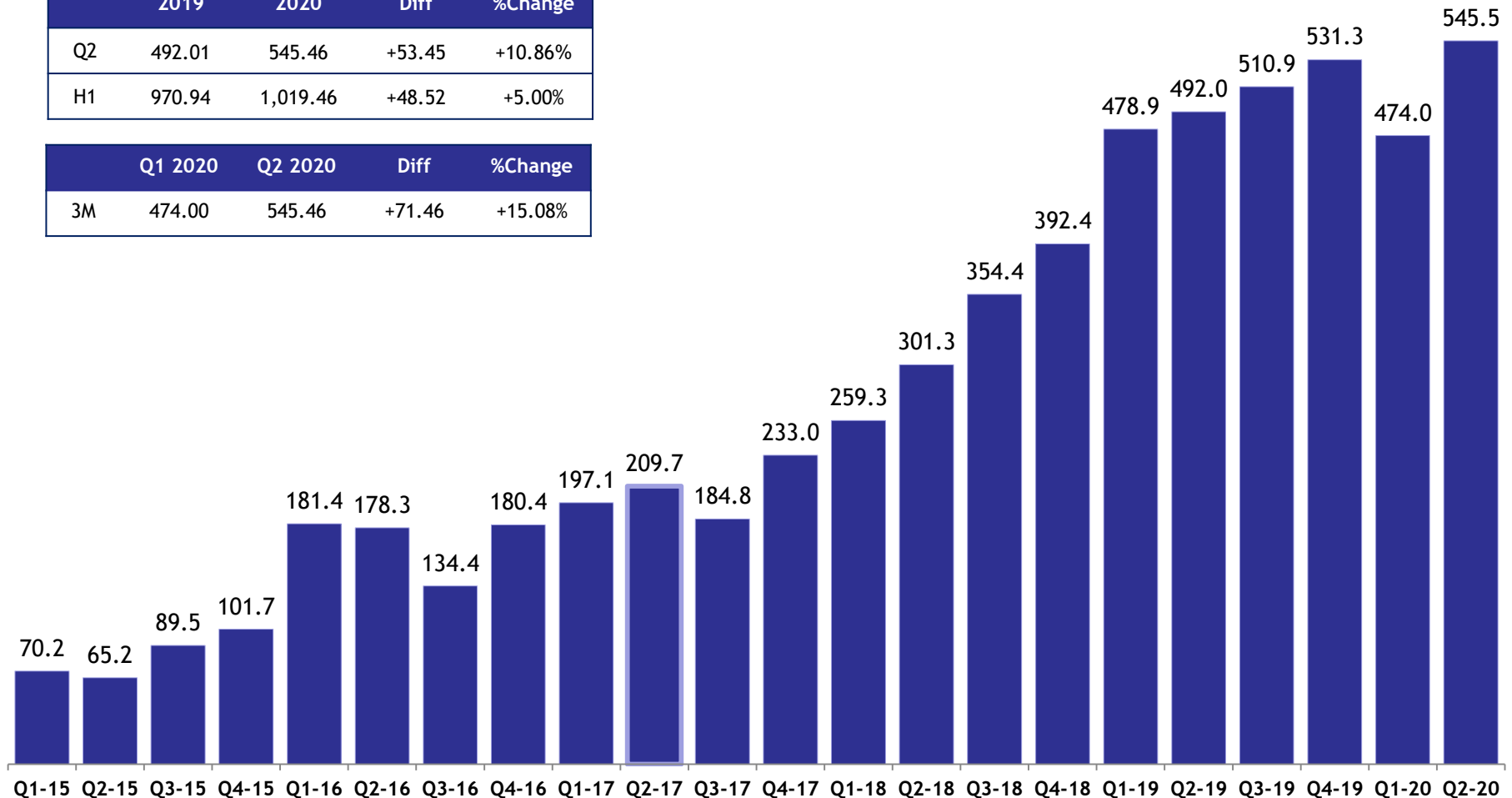



Projected VS Actual EBITDA (excluded F/X)

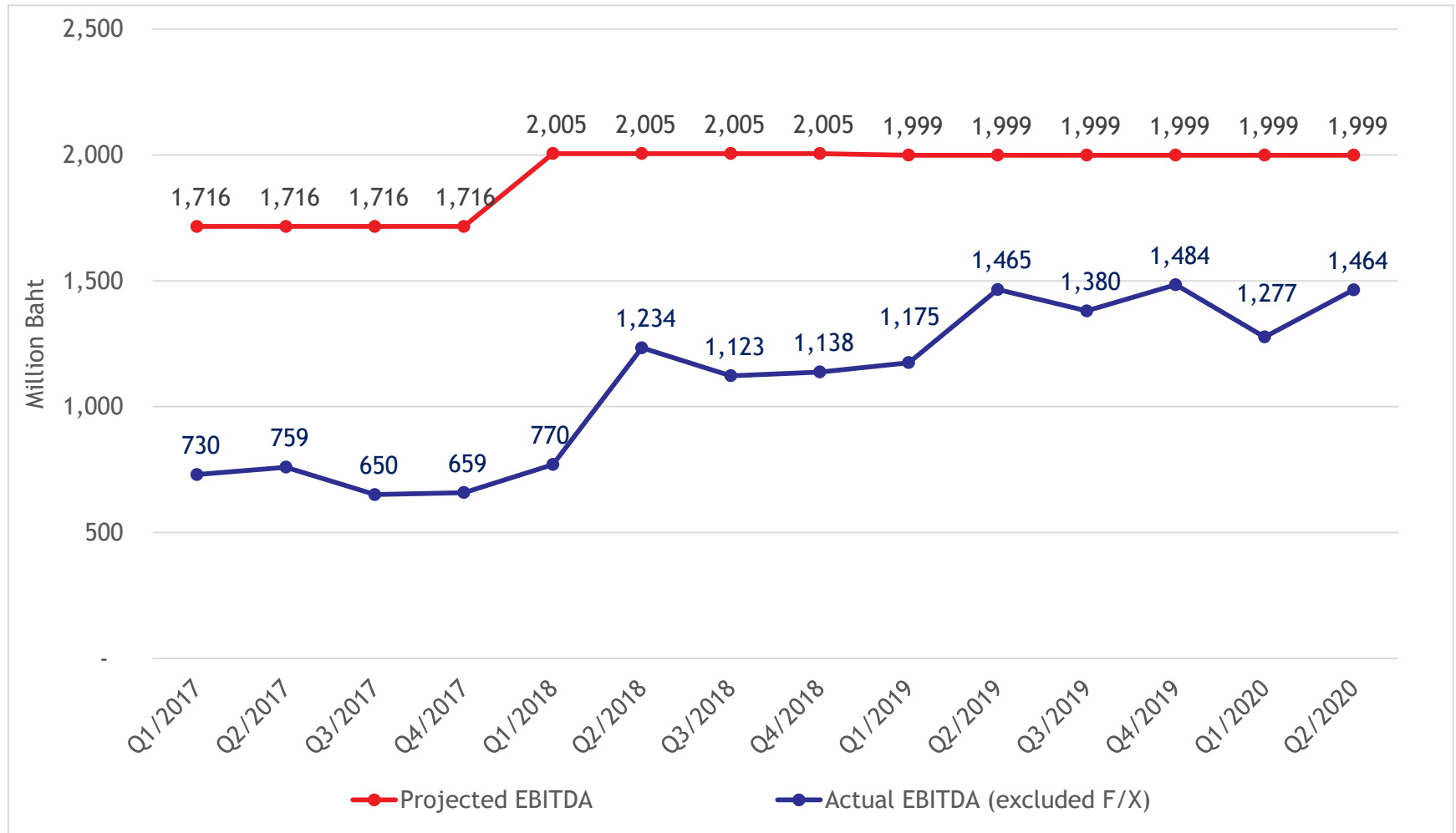

Debt Profile and Leverage Ratios

Interest Bearing Liabilities (THBmm)

Increase in long-term loans from financial institution and related parties

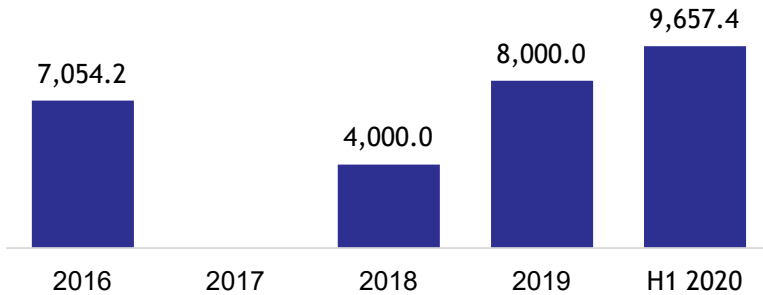

Cash / Cash Equivalents & Other current financial assets (THBmm)

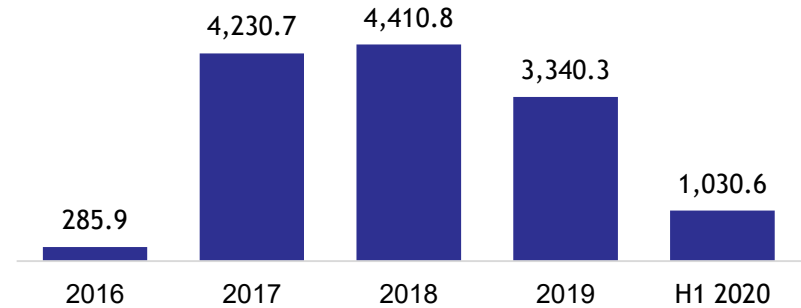

Net Debt⁽¹⁾ to Equity (x)

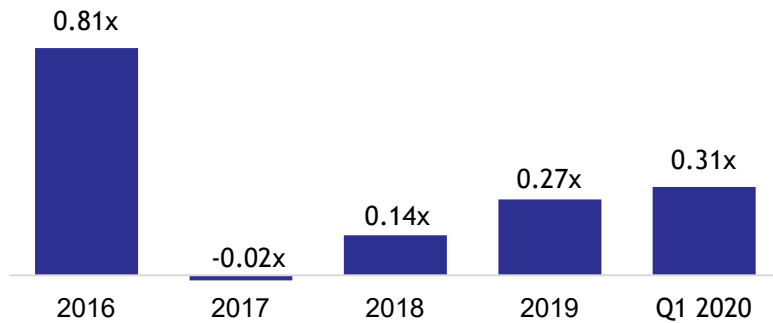

Interest Coverage Ratio⁽²⁾ (x)

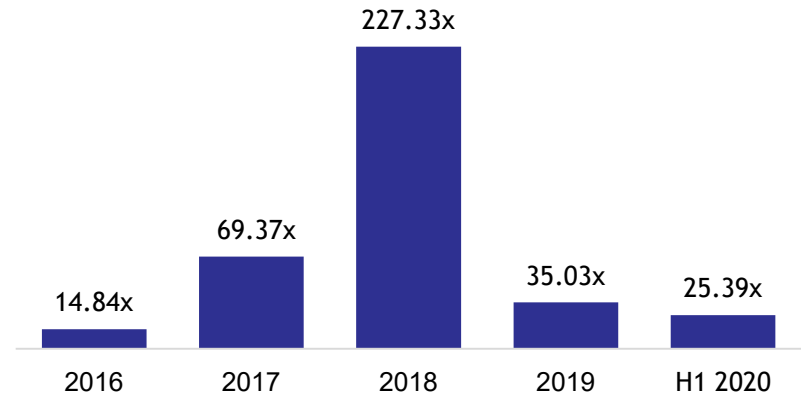

Notes:
 (1) Net debt = Short-term loan from financial institutions + Short-term loan from related parties + Current portion of long-term loan from financial institutions + Long-term loan from financial institutions + Long-term loan from related parties + Debenture - Cash and cash equivalents
 (2) Interest coverage ratio = Cash flows from operating activities before changes in operating assets and liabilities / Finance cost



Key Operation Highlights



Capacity	2009		2016 & 2017		2018		2019			
Power Plants with Electricity Sales to TPIPL	60 MW		70 MW		110 MW		260 MW			
	Note (1)									
	TG1	20 MW	TG1	20 MW	TG1	20 MW	TG1	20 MW		
	TG2	20 MW	TG2	20 MW	TG2	20 MW	TG2	20 MW		
	TG3	20 MW	TG4	30 MW	TG7 ⁽³⁾	70 MW ⁽²⁾	TG7 ⁽³⁾	70 MW ⁽²⁾		
						TG8 ⁽⁴⁾	150 MW			
Power Plants with Electricity Sales to EGAT	-		80 MW (PPA 73 MW)		180 MW (PPA 163 MW)		180 MW (PPA 163 MW)			
			<u>Capacity</u>	<u>PPA</u>	<u>Capacity</u>	<u>PPA</u>	<u>Capacity</u>	<u>PPA</u>		
		TG3	20 MW	18 MW	TG3	20 MW	18 MW	TG3	20 MW	18 MW
		TG5	60 MW	55 MW	TG5	60 MW	55 MW	TG5	60 MW	55 MW
					TG4	30 MW	90MW	TG4	30 MW	90MW
				TG6	70 MW		TG6	70 MW	90MW	
Total Power Capacity	60 MW		150 MW		290 MW		440 MW			

Notes:

- (1) TPIPP completed the installation of additional boilers at RDFPP-20MW and WHPP-40MW in December 2016 and January 2017, respectively
 (2) Can be a backup for sales to EGAT during maintenance period of TG5 and TG6
 (3) TG7 COD in Aug 2018. (under an approved power generation capacity of 40 MW)
 (4) TG8 COD on Jan 25, 2019

WH
 RDF/WH

Coal
 RDF supplement



COD and ADDER Schedule for each plant

SPP	PPA	TG	COD	ADDER	Expiration of ADDER
1	18 MW	TG3	16 JAN 2015	7 Y	JAN 2022
2	55 MW	TG5	6 Aug 2015	7 Y	AUG 2022
3	90 MW	TG4+TG6	18 APR 2018	7 Y	APR 2025



COD and BOI Schedule for each plant

TG	Type	Off taker	COD	TAX INCENTIVE
TG 1-2	WH	TPIPL	Jun 2009	8 Y
TG 3	RDF	EGAT	Jan 2015	8 Y
TG 4	WH	TPIPL/EGAT	Jan 2016/Apr 2018	8 Y
TG 5	RDF	EGAT	Aug 2015	8/5 Y
TG 6	RDF	EGAT	Apr 2018	8 Y
TG 7	Coal/RDF	TPIPL	Aug 2018	-
TG 8	Coal	TPIPL	Jan 25, 2019	8 Y

Trend of FT Adjustment Sell for TPIPL

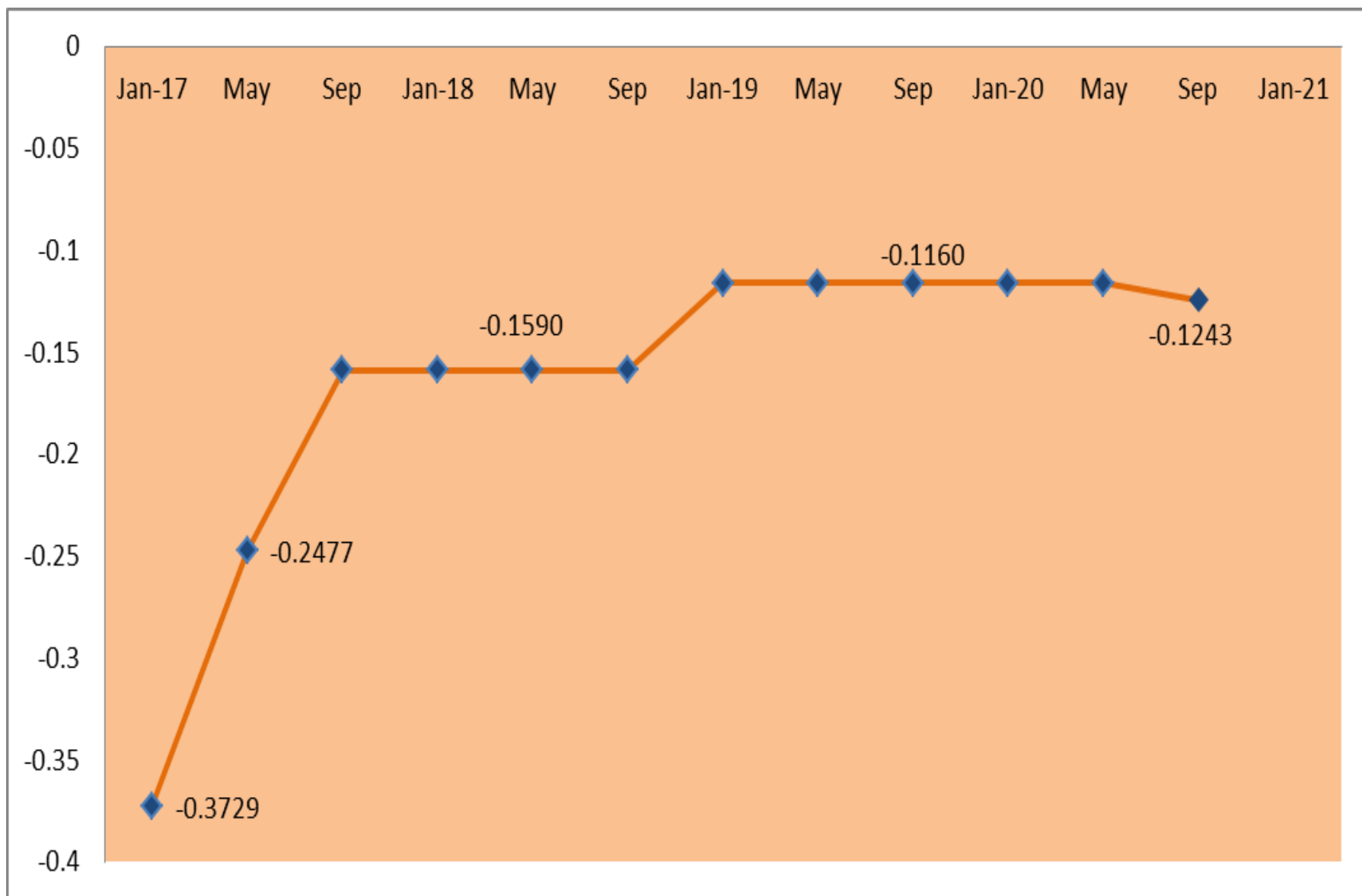

Trend of FT Adjustment Sell for SPP

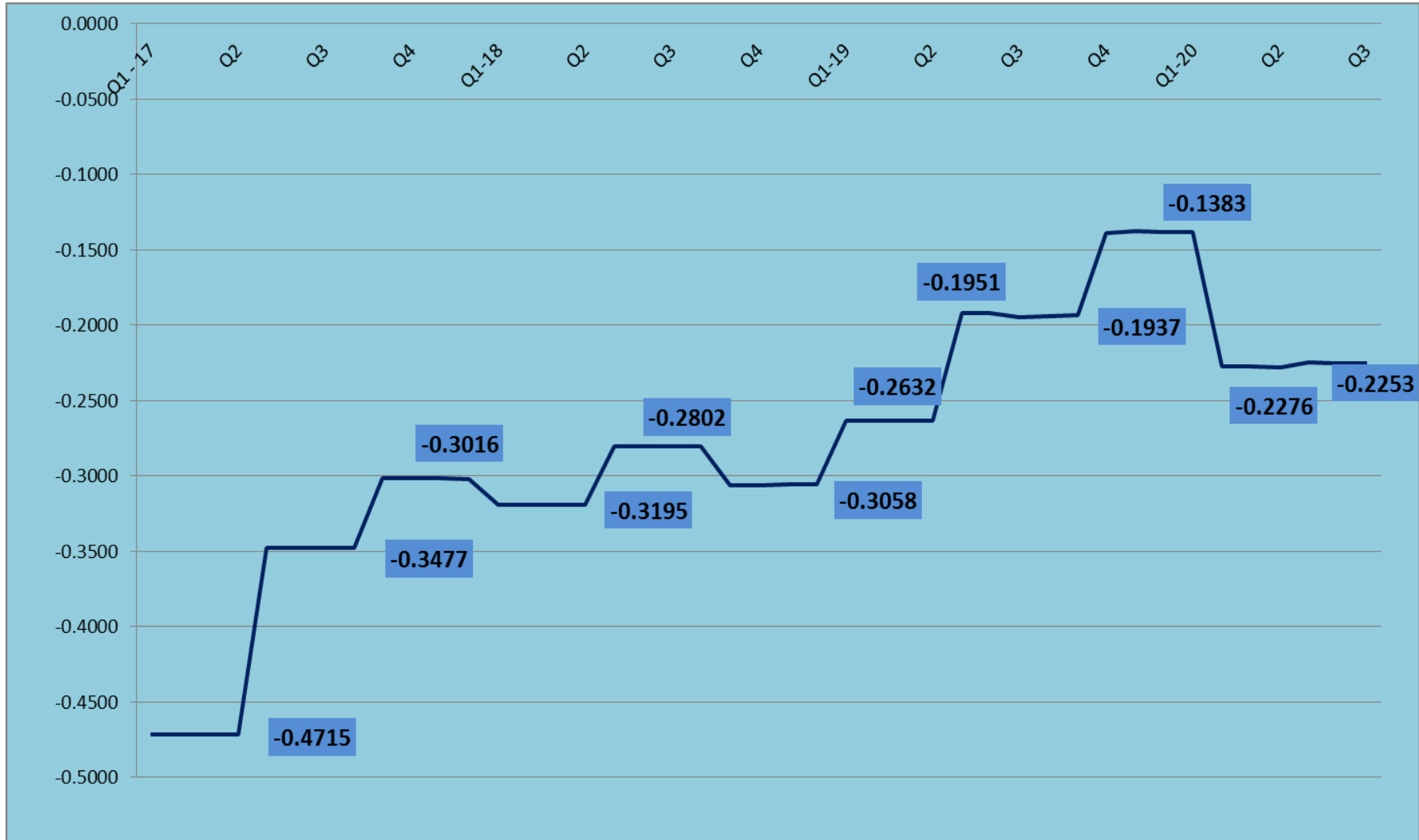



Improvement of Power Plants Utility (with PPA with EGAT)

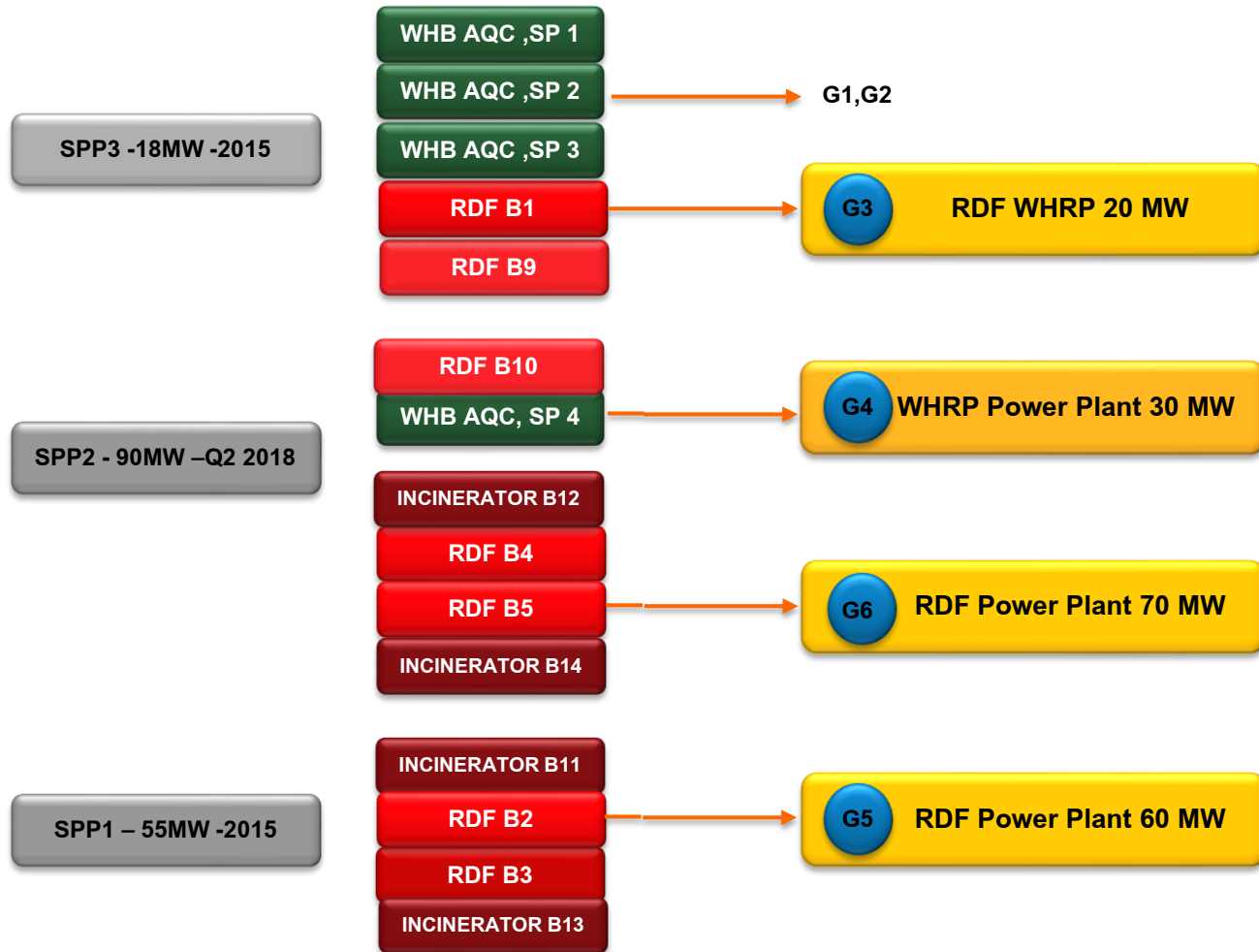



Improvement of of Power Plants (with PPA with TPIPL)

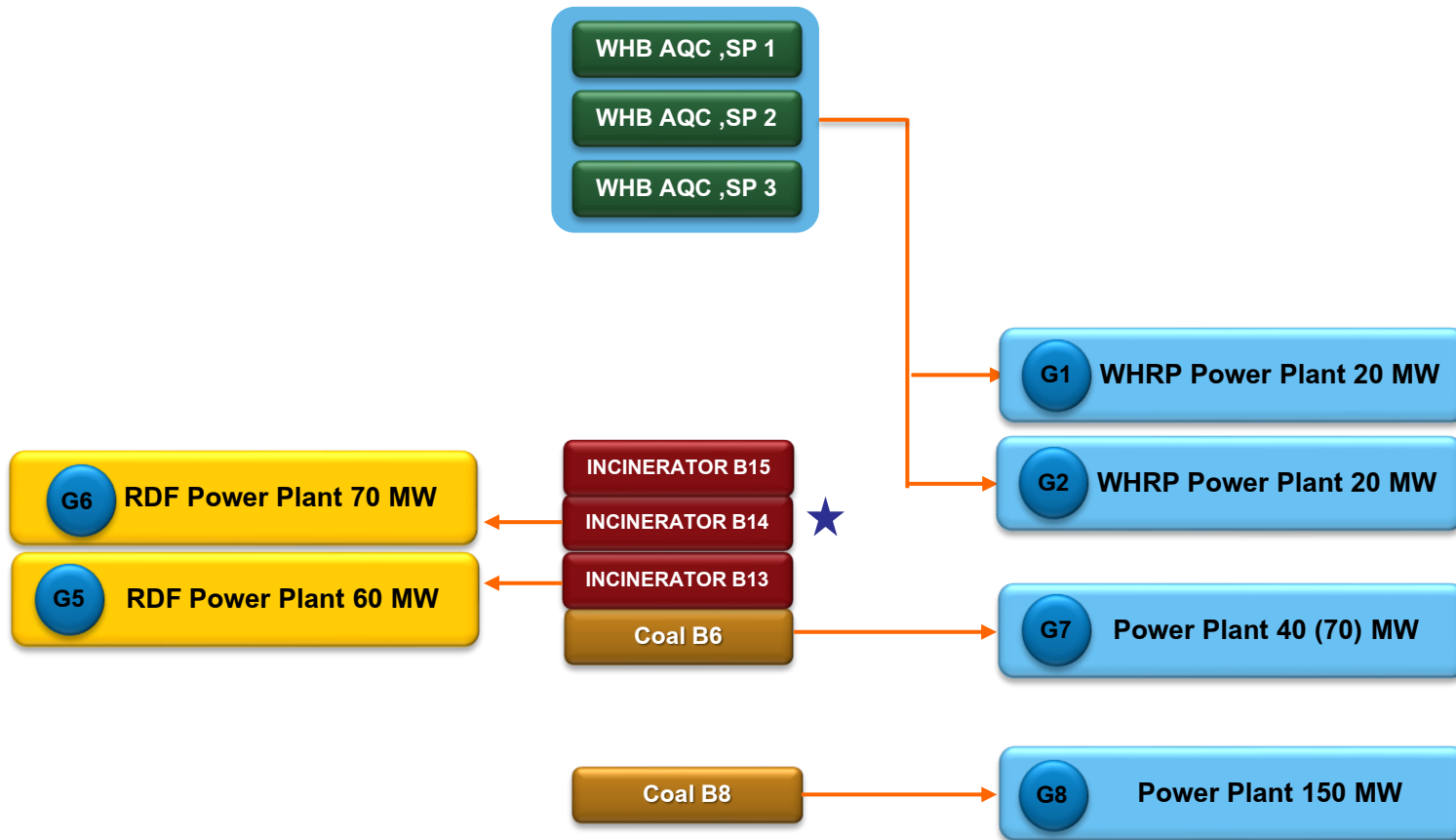

★ Future Project



A solid waste management center

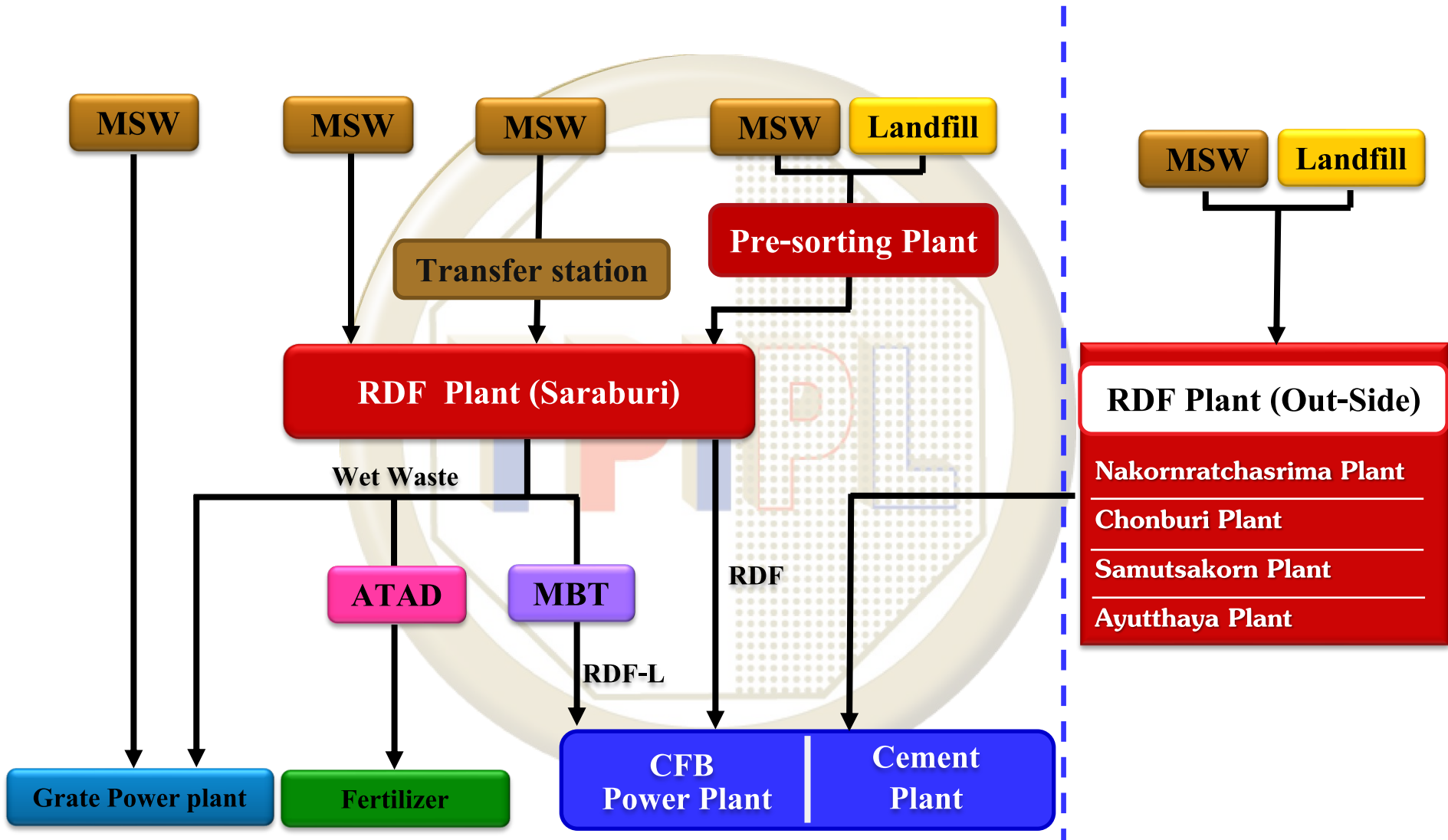

Nakornratchasrima plant



RDF -Rayong Plant



RDF -Ayutthaya Plant



RDF - Chonburi Plant



RDF - Samutsakorn Plant



RDF PLANT SARABURI

1. LINE 1 2 5 6	BMH	4 x 20 T/H	
2. LINE 3 4	SID	2 x 25 T/H	
3. LINE 7 8	SID	2 x 25 T/H	
4. LINE 9 10	SID	2 x 25 T/H	(AUG 2020)
5. LINE 11-13	SID	3 x 25 T/H	(NOV 2020)

RDF PLANT OUTSIDE 5 x 200 T/D

1. Nakorn Ratchasima
2. BANG SAI Ayuttaya
3. NADEE Samutsakorn
4. RAYONG
5. BAN BUENG Chonburi

RDF PLANT PRE-SORTING OUTSIDE 10 x 200 T/D

1. Nakorn Ratchasima
2. BANG SAI Ayuttaya
3. NADEE Samutsakorn
4. RAYONG Rayong
5. PRATUMTHANI
6. IFEC BO WIN Rayong (NOV 2020)
7. LOPBURI
8. CHATABURI
9. Ayuttaya 2
10. NADEE 2

■ RDF Supply for Cement Kiln Plants

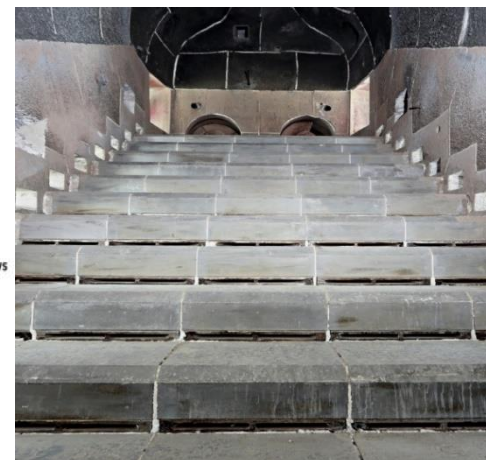
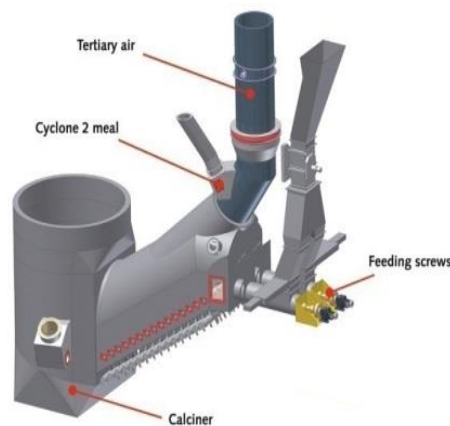
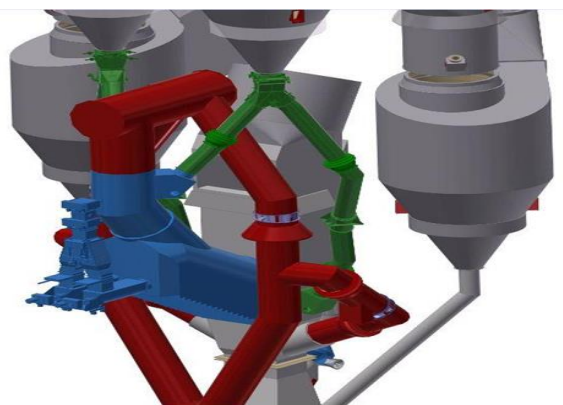

- RDF requirement for coal replacement in 3 Kiln Plants is 1,200 -1,500 ton per day
- Production and Selling RDF to TPIPL is 360,000-450,000 Ton per year
- Estimate Revenue for RDF selling 350-450 Mil baht per year
- Investment of RDF plant 1,000 Mil Baht
- BOI Tax Incentive 8/5
- Project schedule with-in Year 2020-2021



Capacity	2020	2021	2023	2025
Power Plants with Electricity Sales to TPIPL	260 MW	190 MW	190 MW	190 MW.
	TG1 20 MW	TG1 20 MW	TG1 20 MW	TG1 20 MW
	TG2 20 MW	TG2 20 MW	TG2 20 MW	TG2 20 MW
	TG7 (3) 70 MW ⁽²⁾	TG8 (4) 150 MW	TG8 (4) 150 MW	TG8 (4) 150 MW
	TG8 (4) 150 MW			
Power Plants with Electricity Sales to EGAT	180 MW (PPA 163 MW)	220 MW (PPA 203 MW)	276 MW (PPA 232.7 MW)	326 MW (PPA 272.7 MW)
	<u>Capacity</u> <u>PPA</u>	<u>Capacity</u> <u>PPA</u>	<u>Capacity</u> <u>PPA</u>	<u>Capacity</u> <u>PPA</u>
	TG3 20 MW 18 MW	TG7 70 MW 40 MW	TG7 70 MW 40 MW	TG7 70 MW 40 MW
	TG5 60 MW 55 MW		VSP 12 MW 9.9 MW	VSP 12 MW 9.9 MW
	TG4 30 MW 90MW		VSP 12MW 9.9 MW	VSP 12MW 9.9 MW
	TG6 70 MW		VSP 12 MW 9.9 MW	VSP 12 MW 9.9 MW
	B13 - B14 - B15			SPP 50 MW 40 MW
Total Power Capacity	440 MW	440 MW	476 MW	526 MW

■ WH ■ Coal
■ RDF/WH ■ RDF supplement

1. Ban Kotaeo Songkla



Incinerator Power Plant

MSW Boiler Install Capacity 500 ton/day
2x350 ton/day

Generator Capacity 12.5 MW
Net Contract capacity 8.0 MW

MSW Tipping fee 400 Baht/ton
+10 % Every 3 year

Electricity Price 5.78 Baht/Kwh Year 1-8
5.07 Baht/Kwh Year 9-20

Investment Cost 1,805 Mil Baht
Revenue 400 Mil Baht / year

Status TOR Process
COD 2023

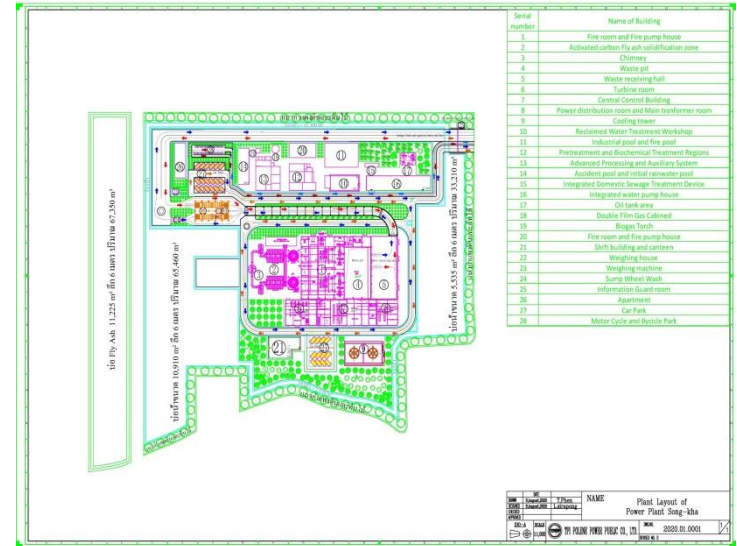



ประกาศองค์การบริหารส่วนจังหวัดสงขลา
เรื่อง ข้อกำหนดและขอบเขตของงาน (Terms of Reference : TOR)
โครงการจัดการขยะมูลฝอยองค์การบริหารส่วนจังหวัดสงขลา

ด้วยองค์การบริหารส่วนจังหวัดสงขลา มีความประสงค์จะดำเนินโครงการจัดการขยะมูลฝอย องค์การบริหารส่วนจังหวัดสงขลา โดยคัดเลือกเอกชนดำเนินการหรือร่วมดำเนินการกำจัดมูลฝอย ตามประกาศกระทรวงมหาดไทย เรื่อง การจัดการมูลฝอย พ.ศ.๒๕๖๐ ข้อ ๑๘ โดยมีวัตถุประสงค์ เพื่อให้การบริหารจัดการขยะมูลฝอยขององค์กรปกครองส่วนท้องถิ่นในจังหวัดสงขลาเป็นไปด้วย ความเรียบร้อย เกิดความประหยัดคุ้มค่า มีประสิทธิภาพตามนโยบายของรัฐบาลและกระทรวงมหาดไทย

ในการนี้ องค์การบริหารส่วนจังหวัดสงขลา ได้กำหนดข้อกำหนดและขอบเขตของงาน (Terms of Reference : TOR) โครงการจัดการขยะมูลฝอยองค์การบริหารส่วนจังหวัดสงขลา ปรากฏตาม รายละเอียดแนบท้ายนี้

จึงประกาศให้ทราบโดยทั่วกัน

ประกาศ ณ วันที่ ๒๐ กรกฎาคม พ.ศ. ๒๕๖๓



(นายประทีป สุพรรณ)
ปลัดองค์การบริหารส่วนจังหวัด ปฏิบัติหน้าที่
นางสาวรุ่งนภา บริหารส่วนจังหวัดสงขลา

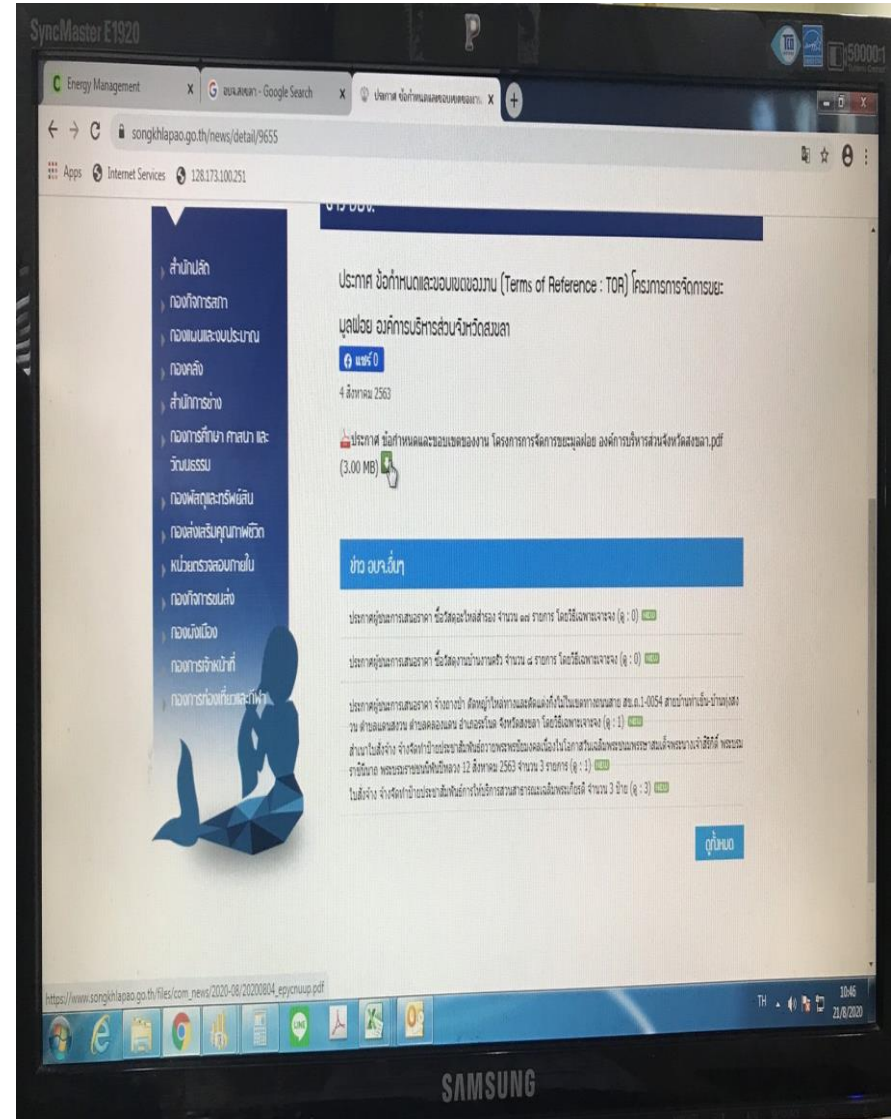

2. Municipality Na Klang Nakorn Ratchasrima



Incinerator Power Plant

MSW	500	ton/day
Boiler Install Capacity	2x350	ton/day
Generator Capacity	12.5	MW
Net Contract capacity	8.0	MW
MSW Tipping fee	400 +10 %	Baht/ton @ Every 3 year
Electricity Price	5.78 5.07	Baht/Kwh Year 1-8 Baht/Kwh Year 9-20
Investment Cost	1,900	Mil Baht
Revenue	400	Mil Baht / year
Status	TOR Process	
COD	2023	

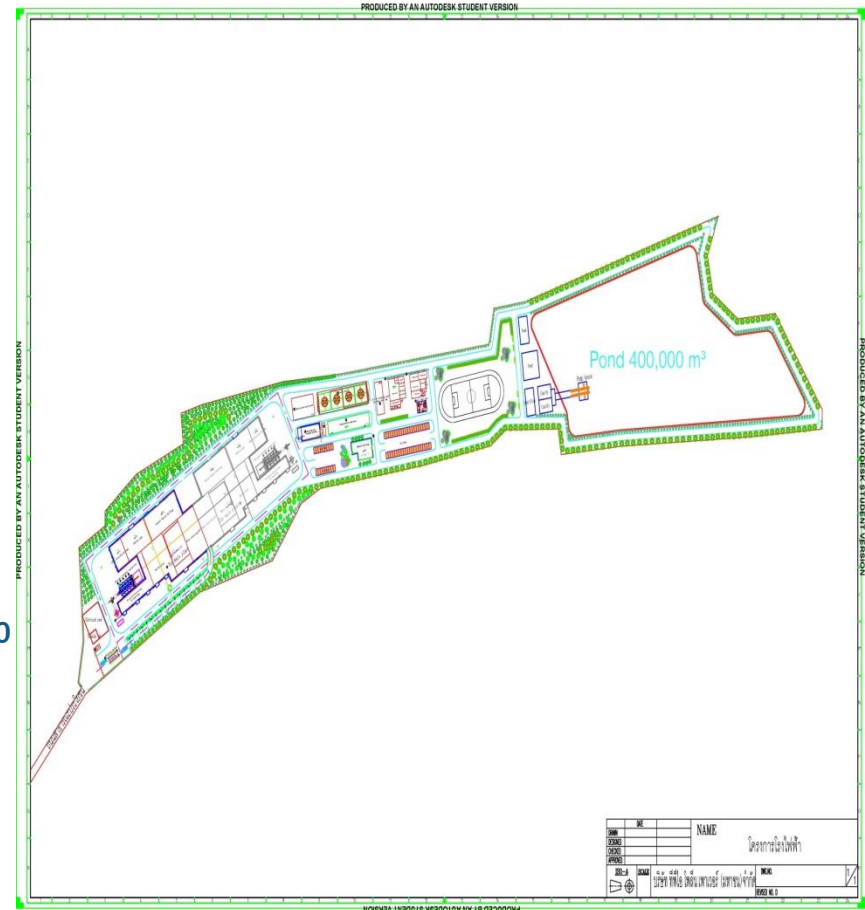

3. Municipality Muang Nakorn Ratchasrima



Incinerator Power Plant

MSW	500	ton/day	
Boiler Install Capacity	2x350	ton/day	
Generator Capacity	12.5	MW	
Net Contract capacity	9.9	MW	
MSW Tipping fee	400	Baht/ton	
	+ Inflation rate		
Electricity Price	5.78	Baht/Kwh	Year 1-8
	5.07	Baht/Kwh	Year 9-20
Investment Cost	2,200	Mil Baht	
Revenue	500	Mil Baht / year	
Status	TOR Process		
COD	2023		

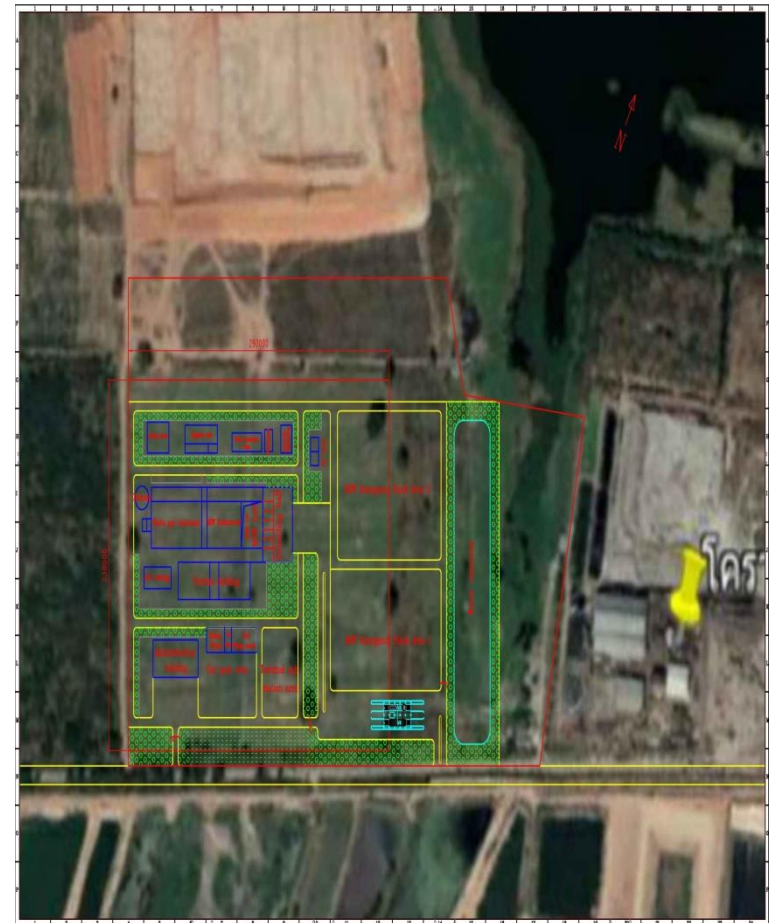

4. Municipality Thap Kwang Saraburi



RDF and MSW TG 7

3 x 80 T/H STEAM BOILER 5.5 MPa (B13,B14 and B15) PROJECT

Boiler Install Capacity B13-15	3x 750	ton/day
Generator Capacity	70	MW
Net Contract capacity	40	MW
MSW Tipping fee	400 +10 %	Baht/ton Every 3 year
Electricity Price	3.66	Baht/Kwh
Investment Cost	500	Mil Baht
Revenue	1,200	Mil Baht / yea
Status	Province Approved	
COD	2022	



Picture by Drone
2020.08.19

5. Chalerm Phra Kiat District Saraburi



Green Network	Biomass	
Boiler Install Capacity	2x35	ton/hour
Generator Capacity	12.5	MW
Net Contract capacity	9.9	MW
Electricity Price	4.264	Baht/Kwh
Investment Cost	1,000	Mil Baht
Revenue	250	Mil Baht / year
COD	2022	

■ Chonburi 2x 500 ton /day

■ Chanthaburi 500 ton/day

■ Udon Thani 500 ton/day

■ Ayuttaya 500 ton/day

The development of Southern Economic Zone (SEZ)

- On October 4th 2016, the cabinet has a resolution to approve the promotion of the “Security, Prosperity, Sustainability Triangle Model City 4 Projects”
 1. Betong District, Yala Province
 2. Su ngai go lok District, Narathiwat Province
 3. Nhong Jik District, Pattani Province
 4. Chana District, Songkhla ProvinceHowever, the cabinet only approve to start the development of the first three districts to avoid all investments flocking into only Chana District.
- During 2018-2019, the Southern Border Provinces Administrative Center (SBPAC) has decided that it is the right time to start the development of the fourth district as already approve by the cabinet. The SBPAC went out to discuss the possibility with all related sectors, including the private sector. After getting all the needed information, the SBPAC let the cabinet to approve the project again.
- On May 7th 2019, the cabinet has a resolution to approve the promotion of the fourth district of the “Security, Prosperity, Sustainability Triangle Model City 4 Projects” in Chana District
- On October 31st 2019, the Southern Corridor Strategy Development Committee (SCSDC) has a resolution to let the SBPAC use section 7, 9, 10 and 18 of the Southern Border Provinces Administration Act.
- On January 21st 2020, the cabinet has a resolution to approve and acknowledge the SCSDC’s resolution on Oct 31st.
- On July 16th 2020, the SCSDC has a resolution to approve the SBPAC to contact all needed government agencies to change the planning permission of Chana District.
- On August 18th 2020, the cabinet has a resolution to approve and acknowledge the SCSDC’s resolution on July 16th.

Q & A